

Форма № ЕК0007

ID 5180

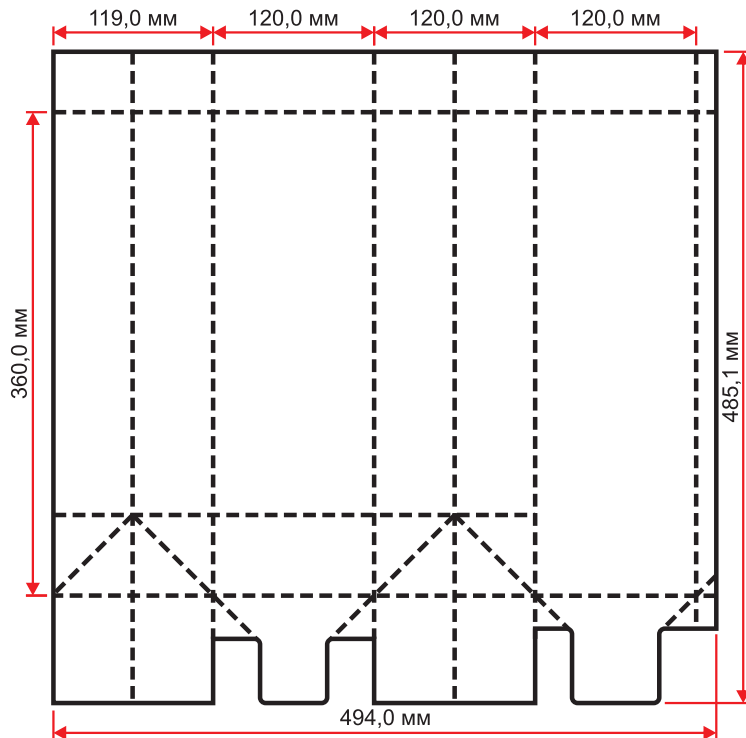

Форма № ЕК0212

ID 5500

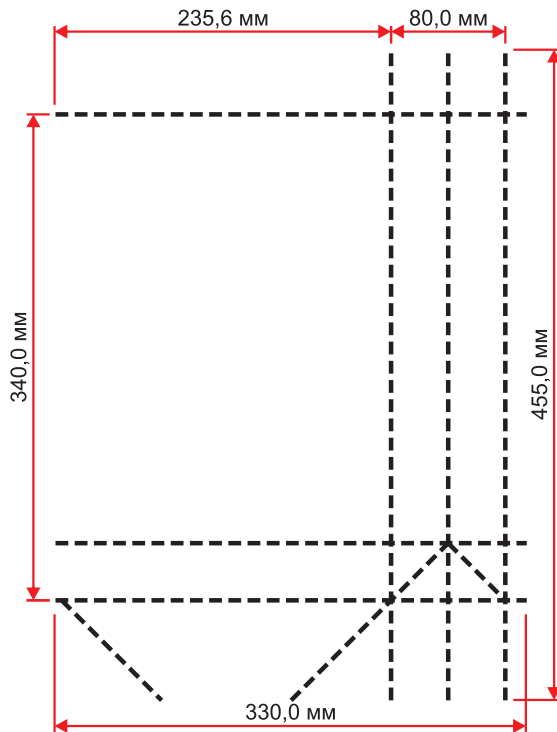

Форма № ЕК0243

ID 5154

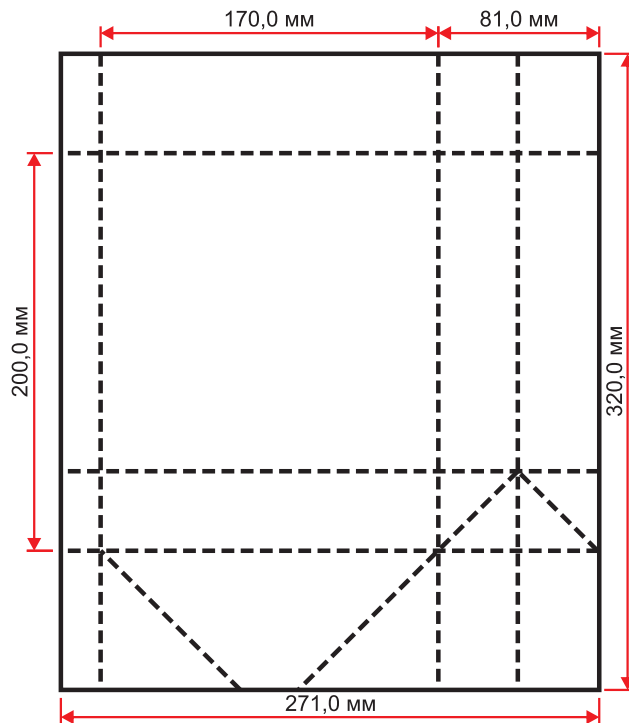

Форма № ЕК0279

ID 5064

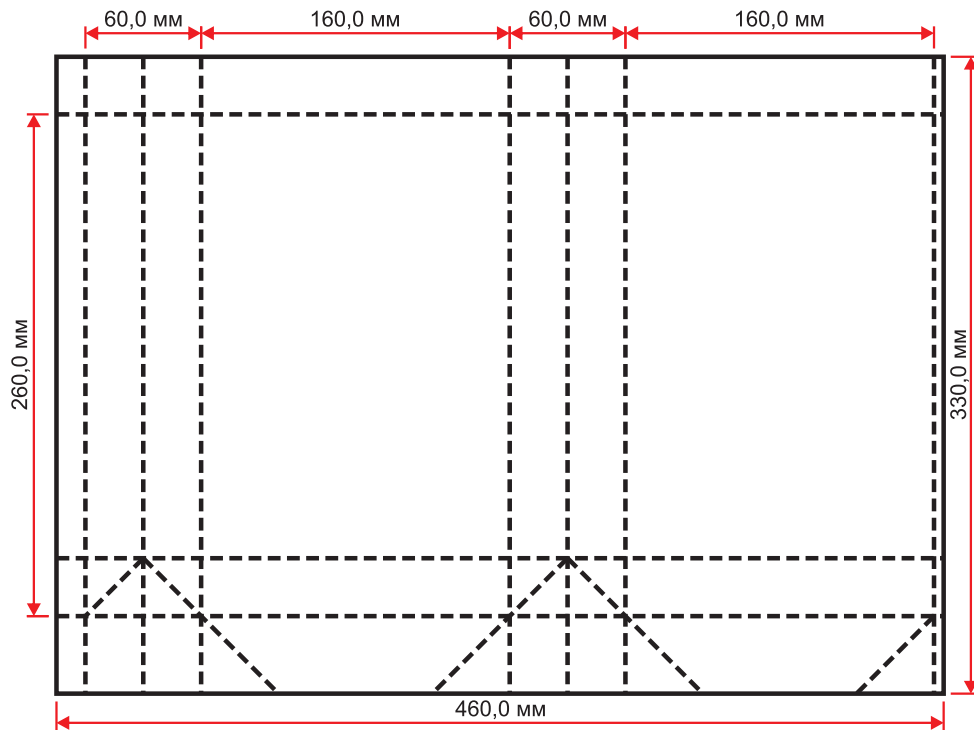

Форма № ЕК0346

ID 5061

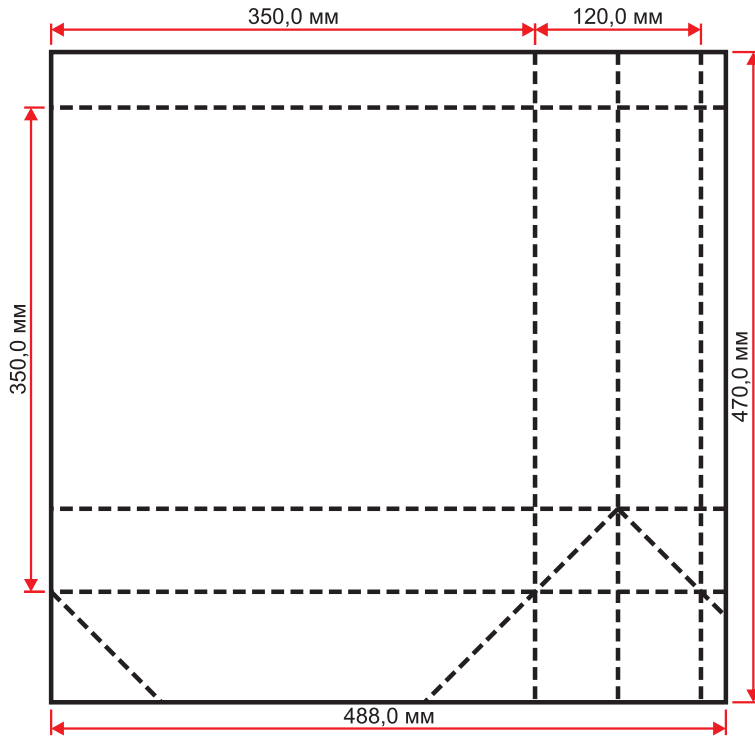

Форма № ЕК0353

ID 5161

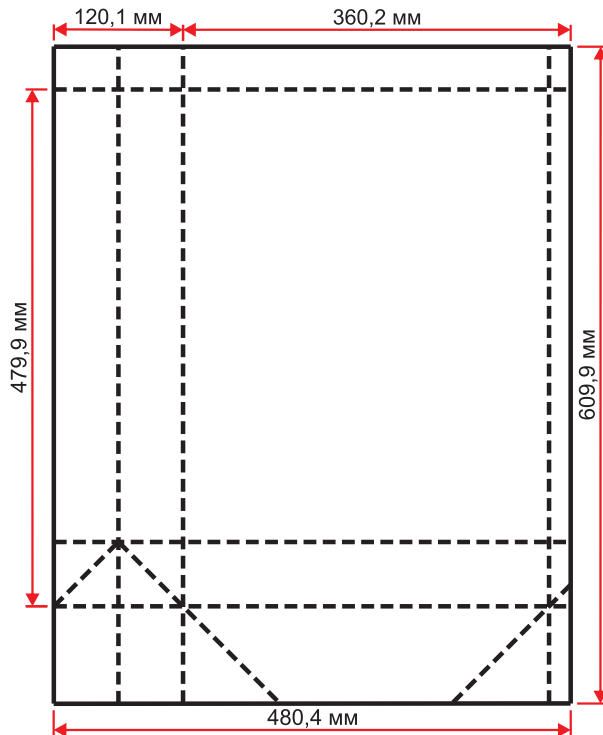

Форма № ЕК0433

ID 5119

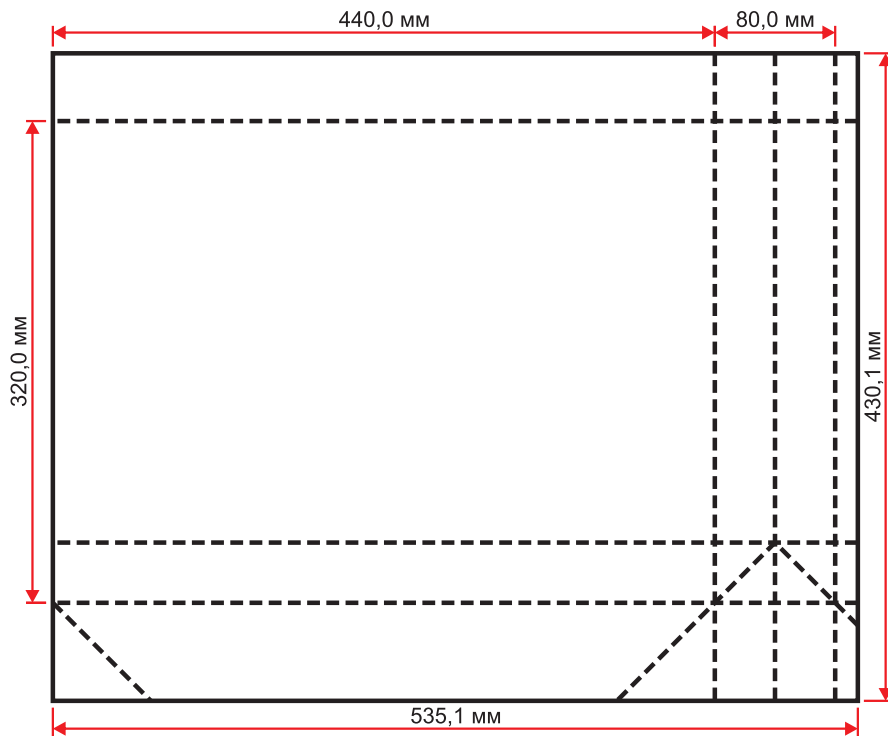

Форма № ЕК0460

ID 5125

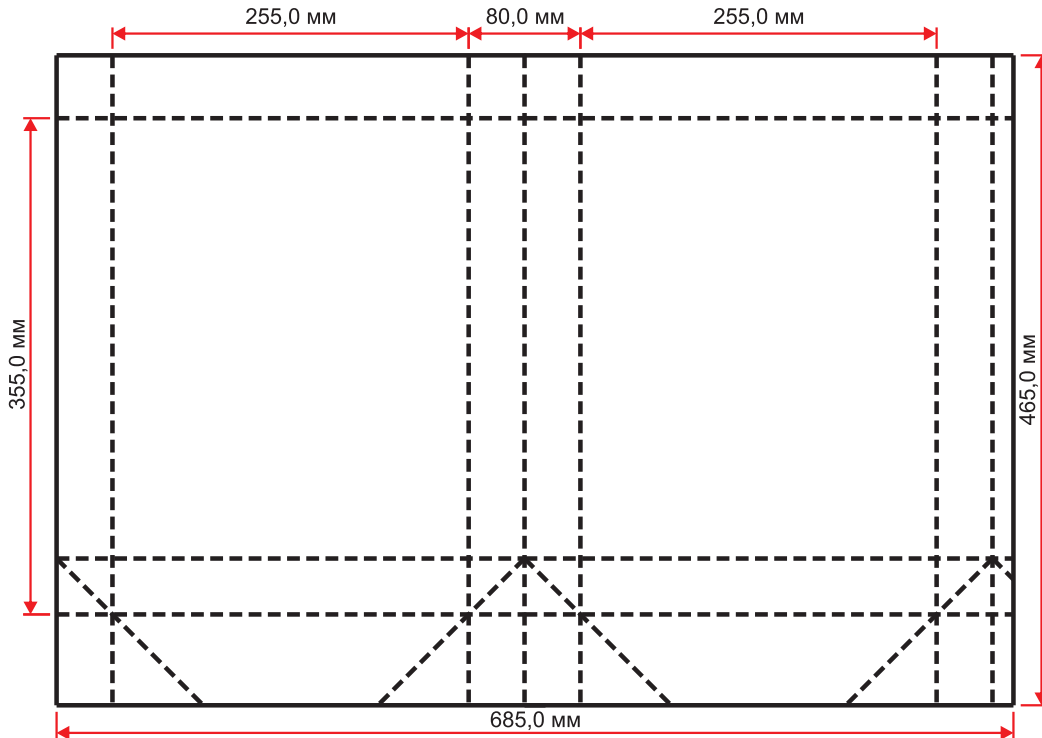



Форма № ЕК0602

ID 6125

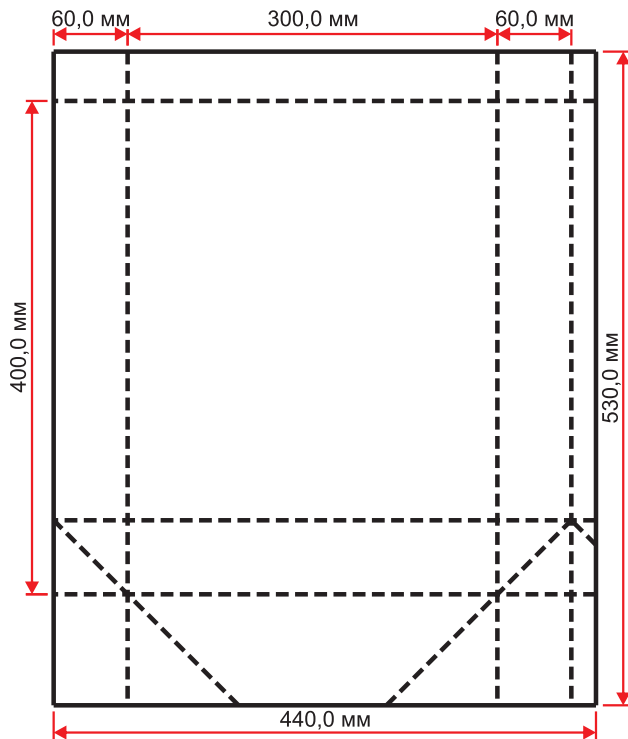

Форма № ЕК0630

ID 6136

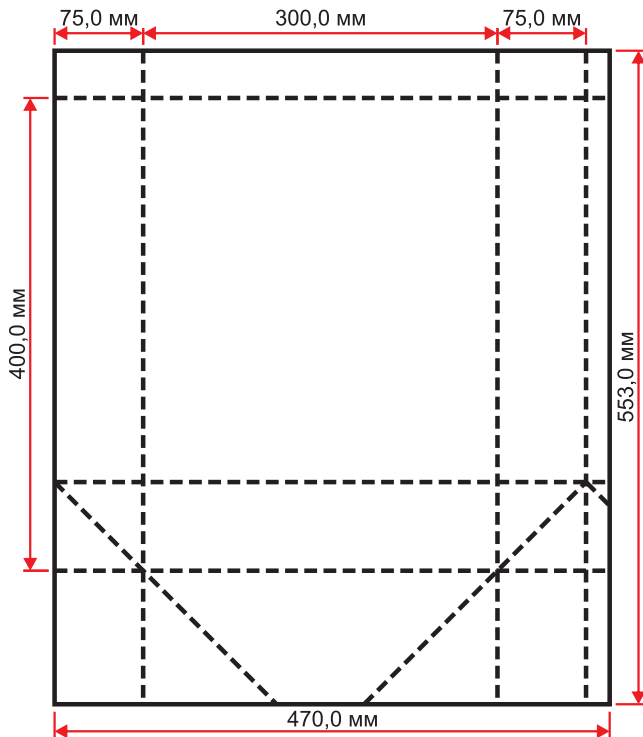

Форма № ЕК0719

ID 6176

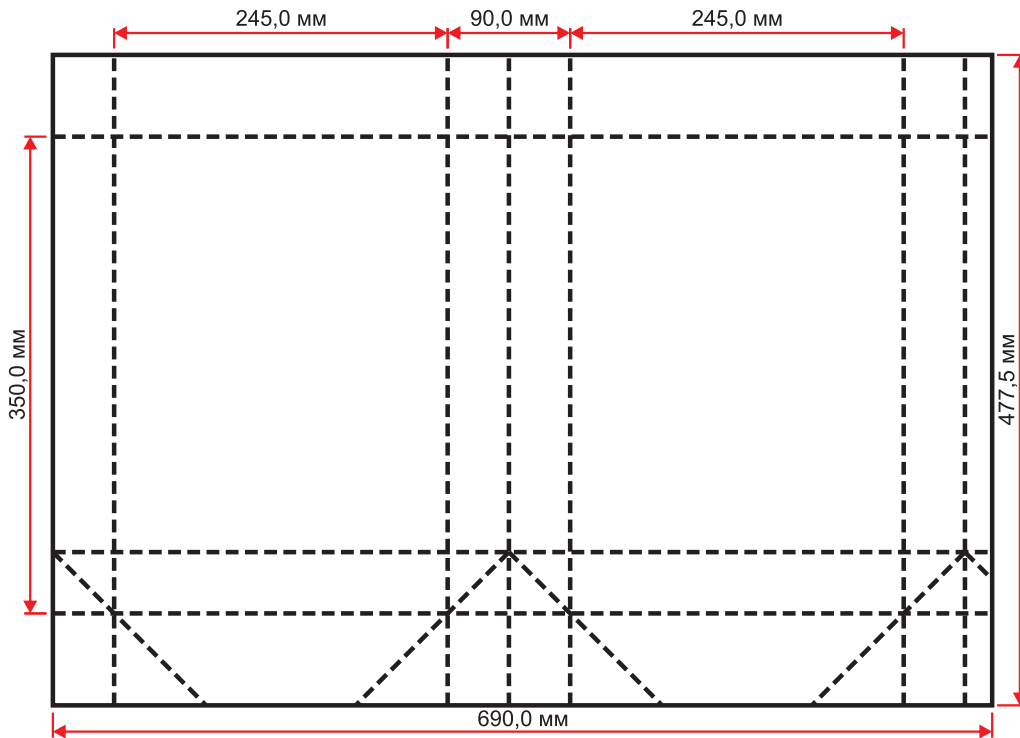

Форма № ЕК1122

ID 6584

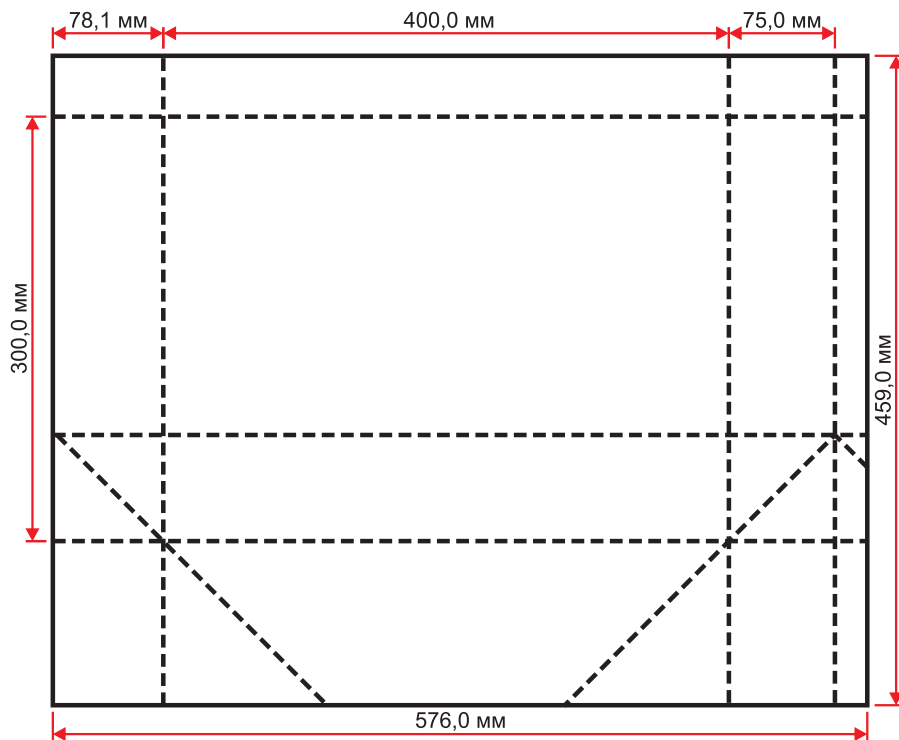

Форма № ЕК1196

ID 6960

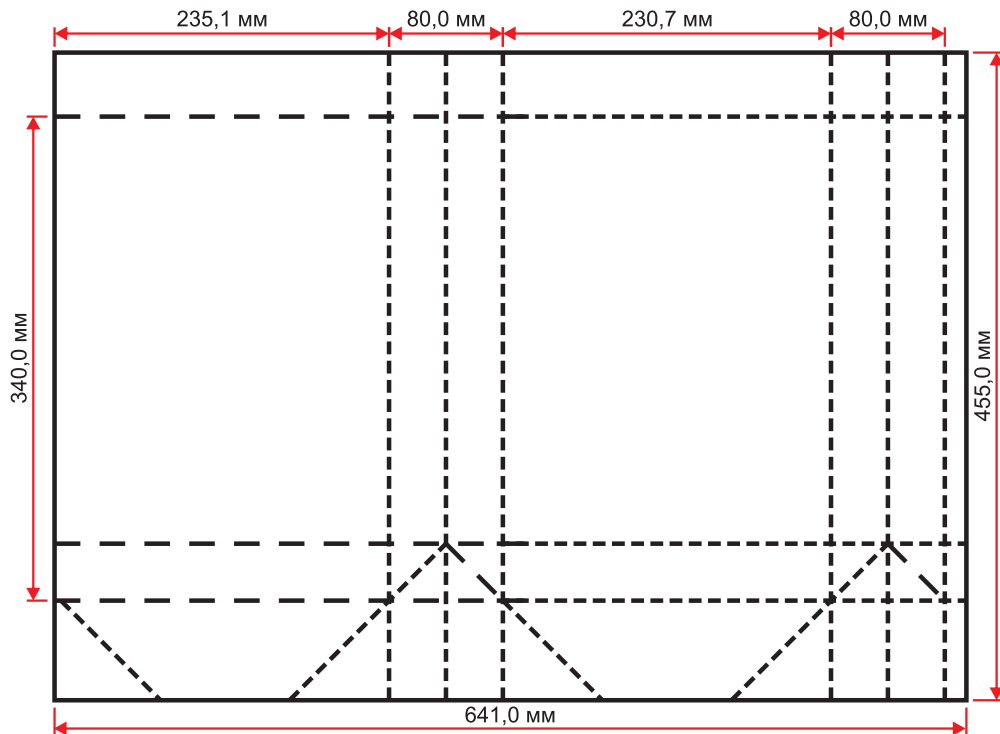

Форма № ЕК1197

ID 6964

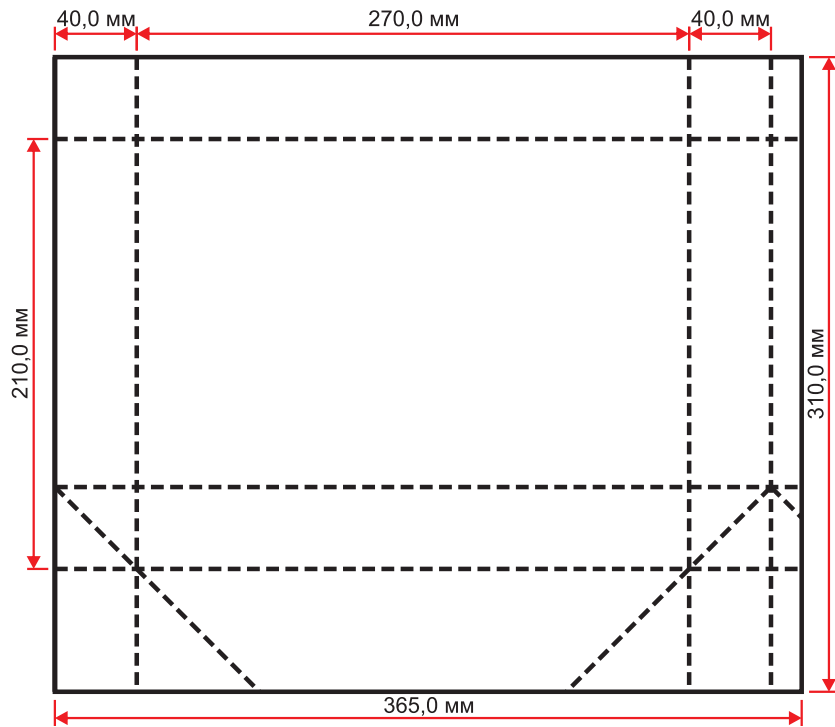

Форма № ЕК1218

ID 7142

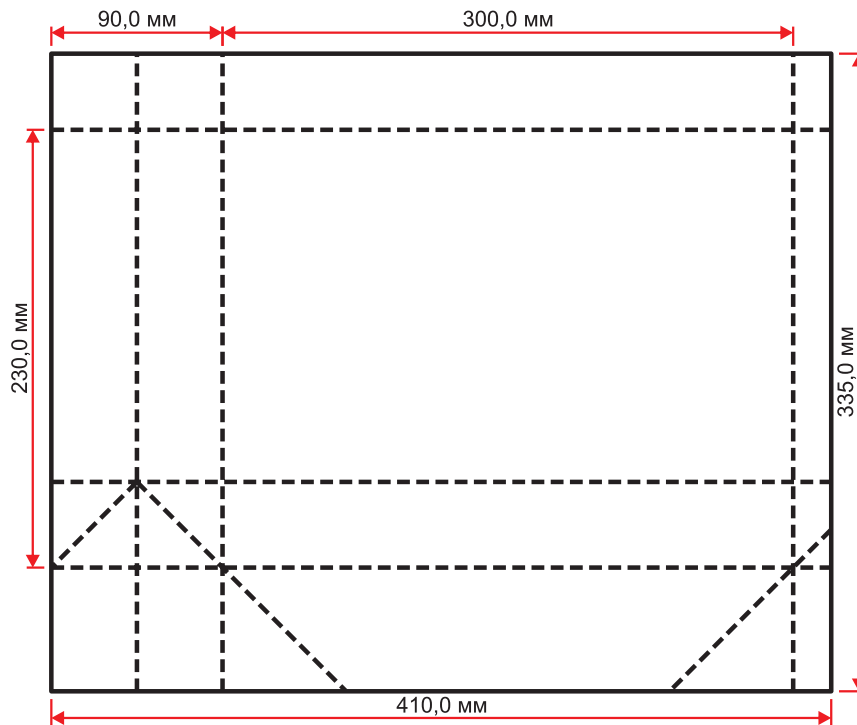

Форма № ЕК1249

ID 7289

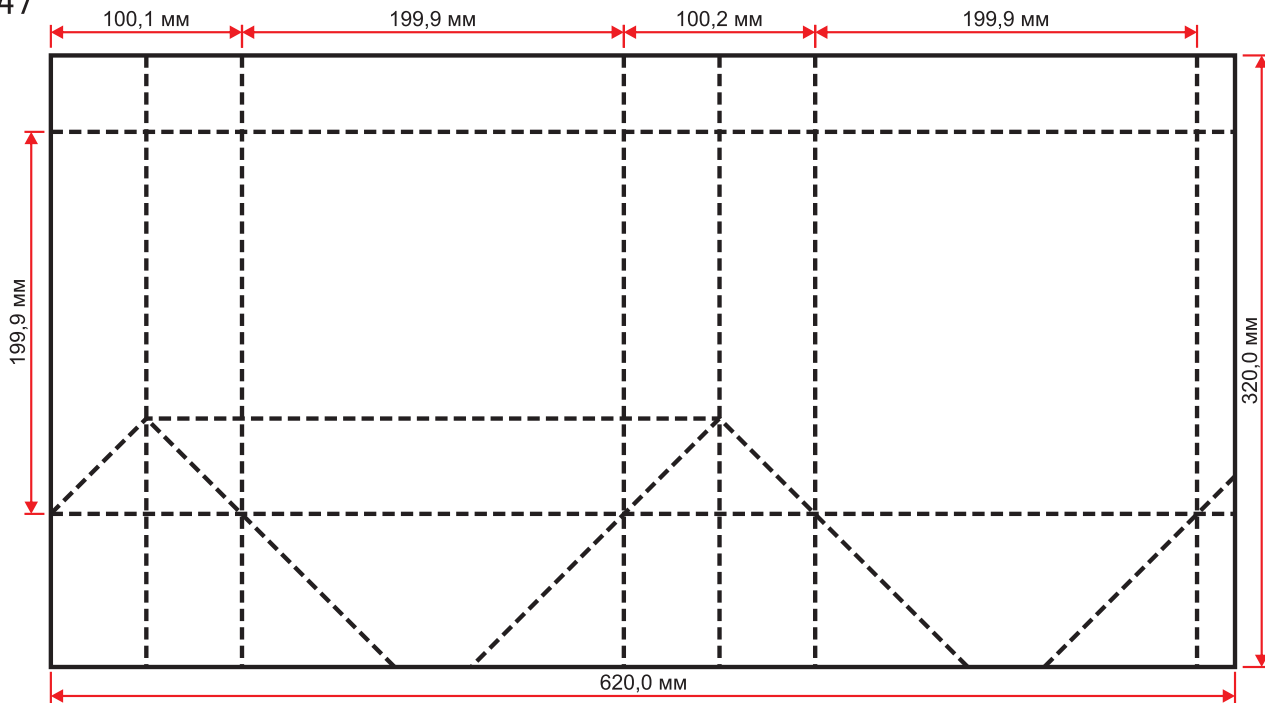



Форма № ЕК1268

ID 7387

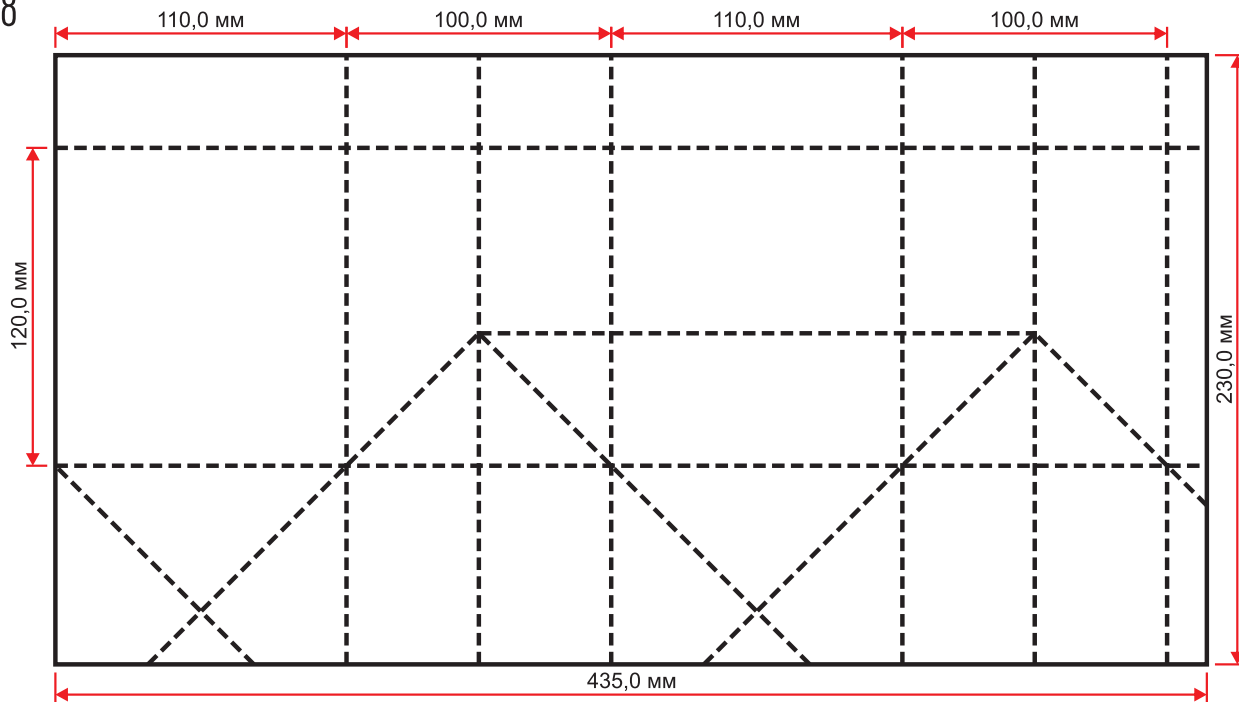

Форма № ЕК1337

ID 7704

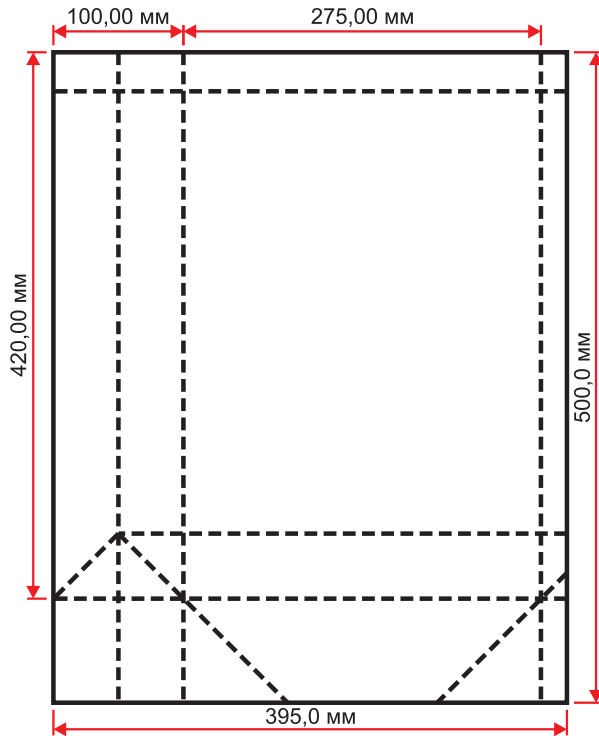

Форма № ЕК1430

ID 8705

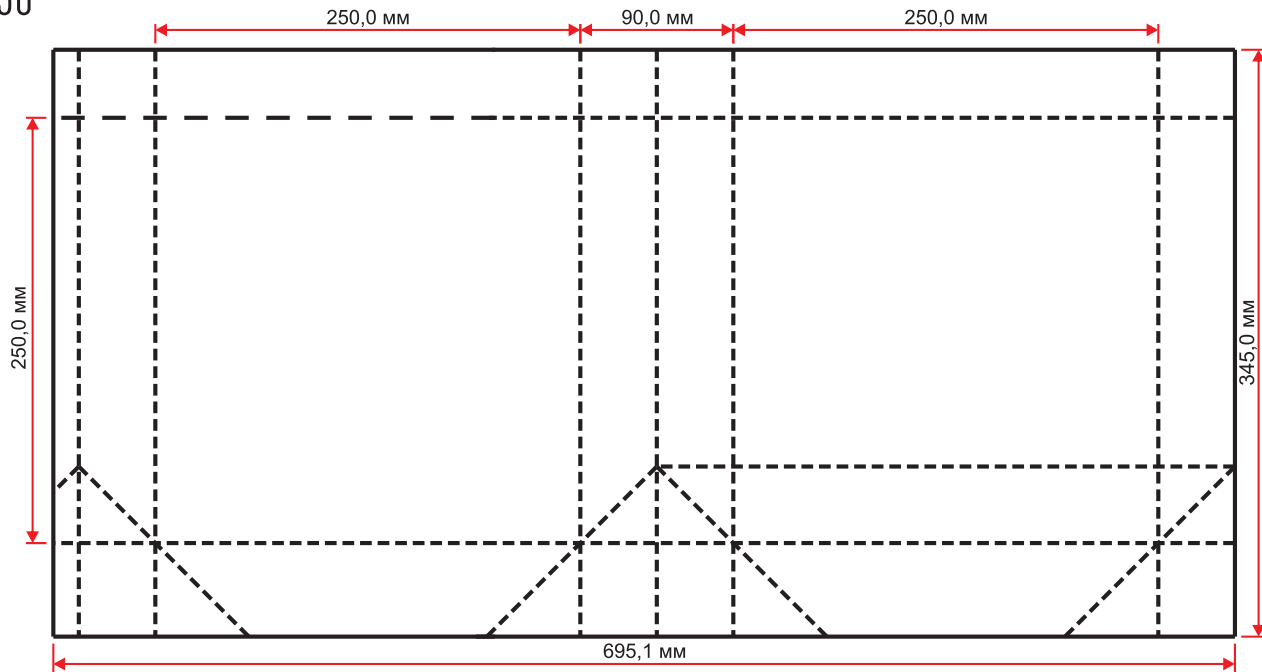

Форма № ЕК1467

ID 8854

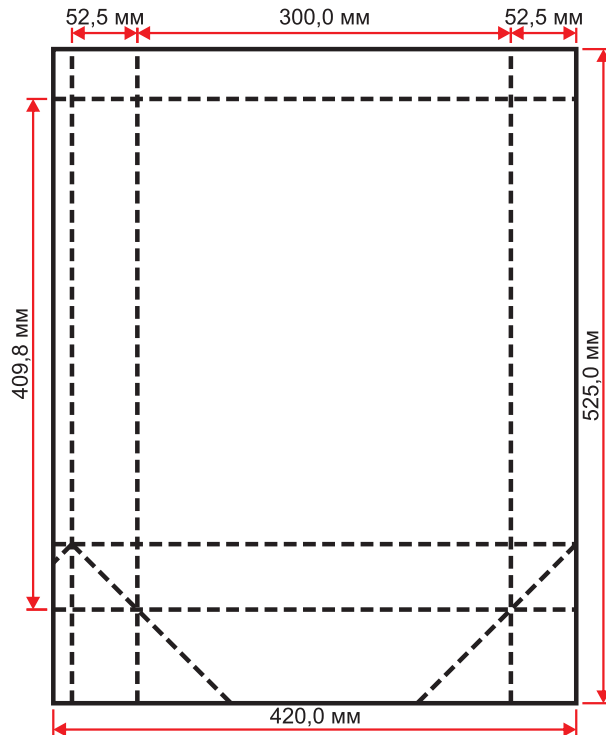

Форма № ЕК1468

ID 8855

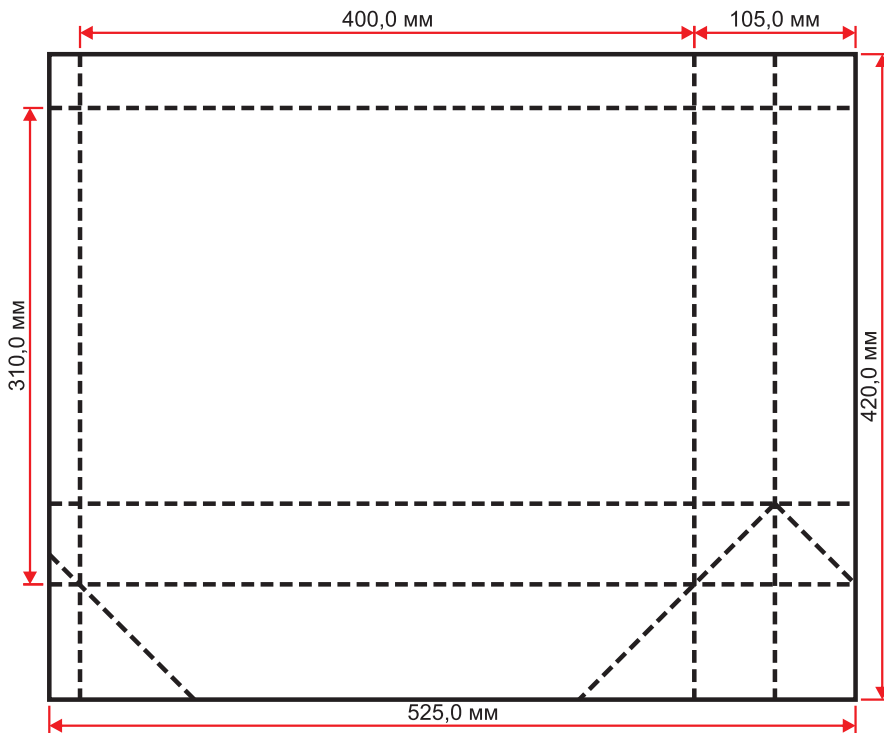

Форма № ЕК1640

ID 9691

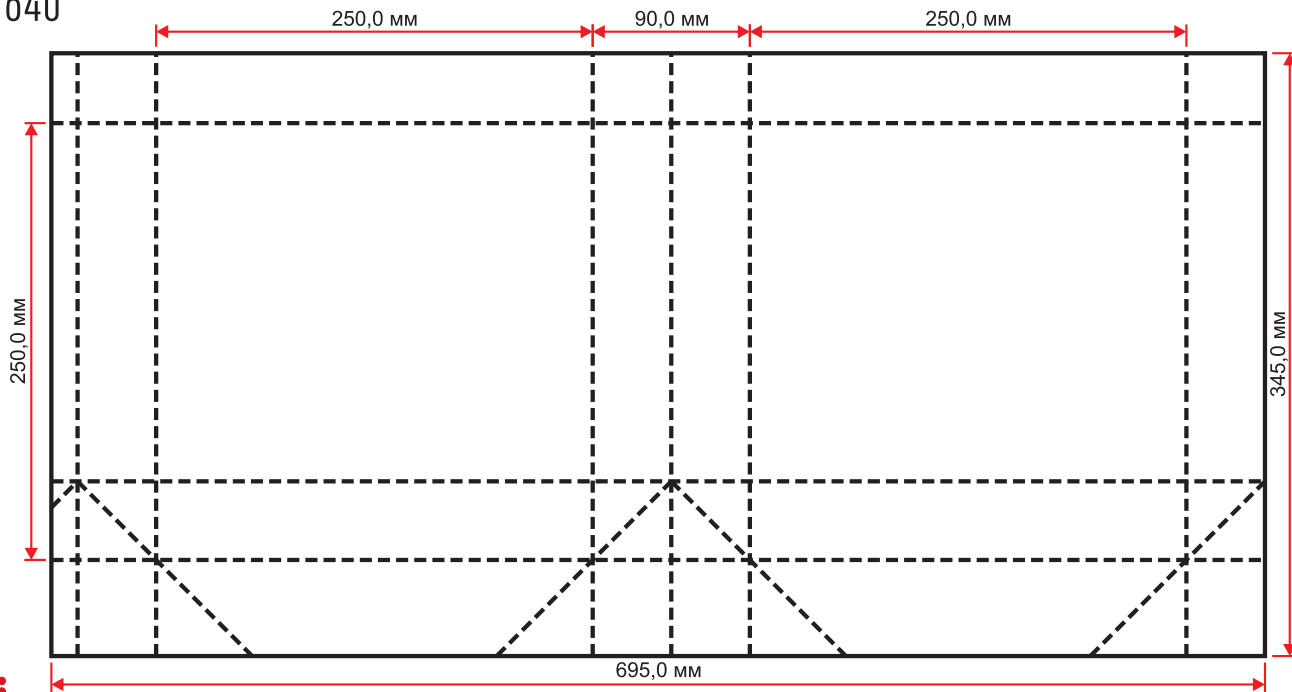

Форма № ЕК1648

ID 9721

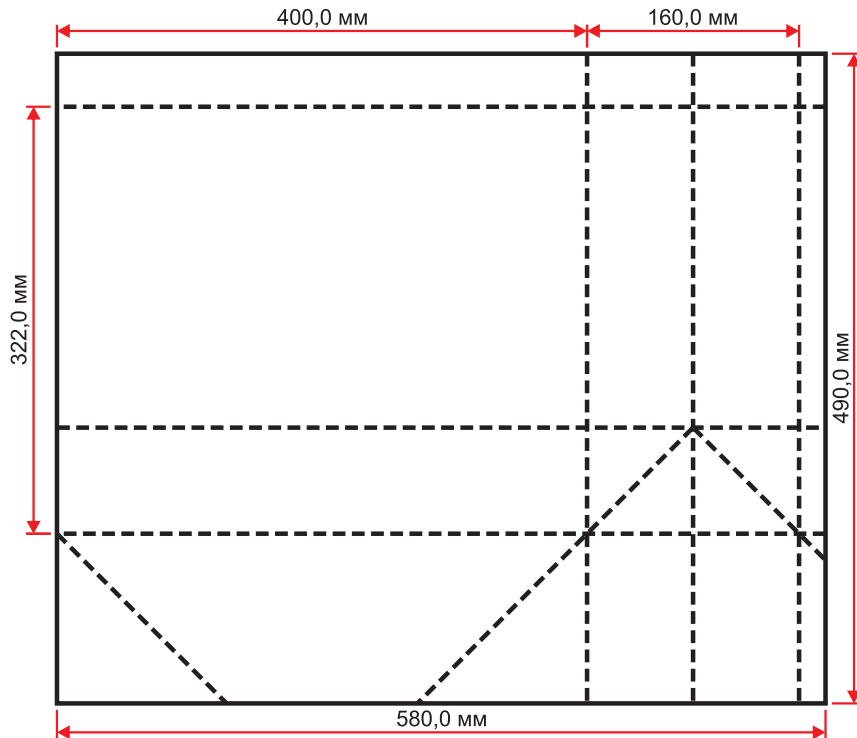

Форма № ЕК1774

ID 10374

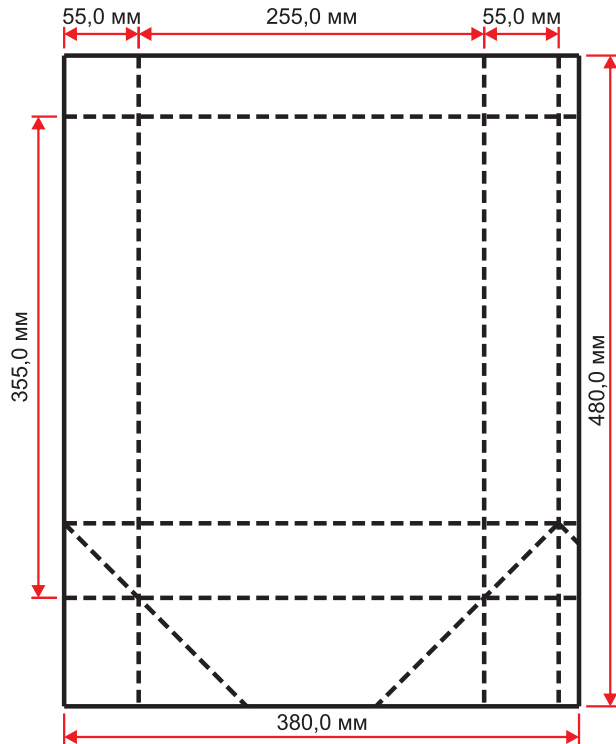



Форма № ЕК1857

ID 10788

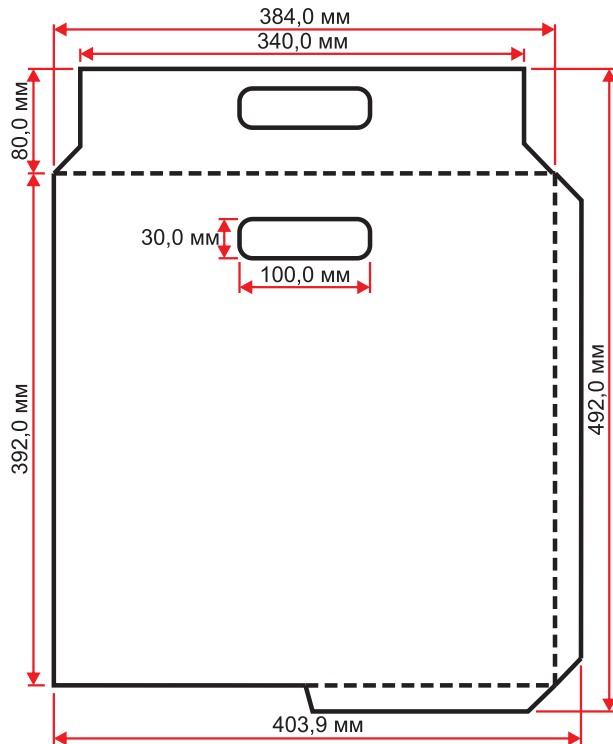

Форма № ЕК1895

ID 10973

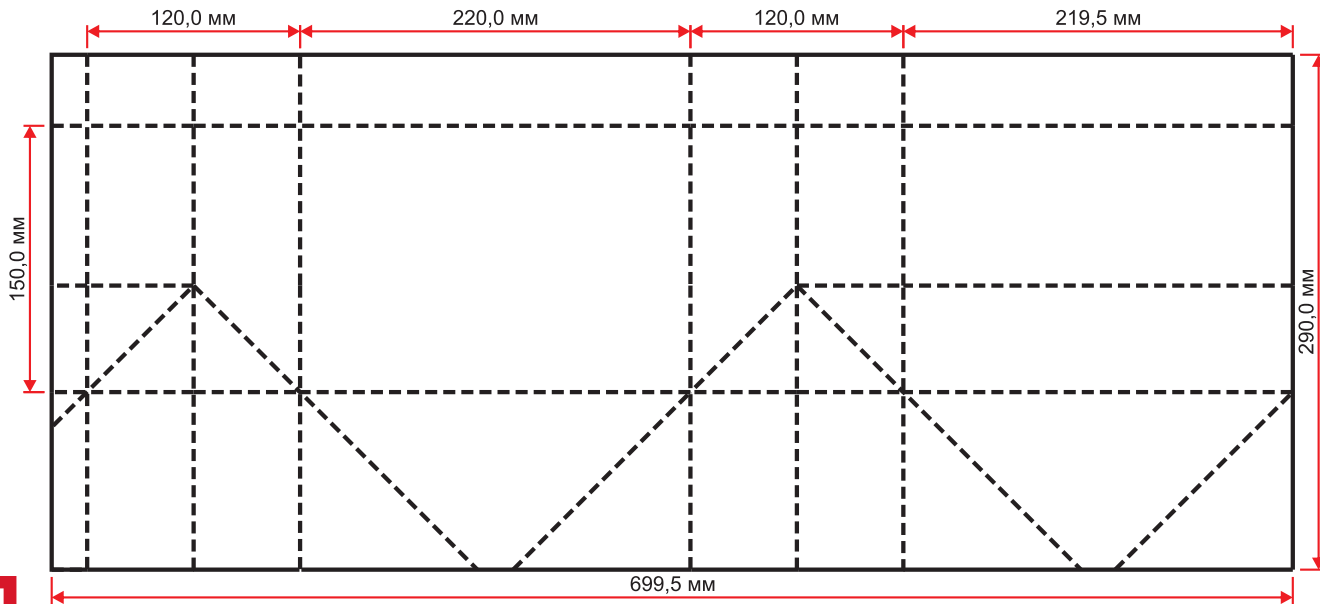

Форма № ЕК1907

ID 11051

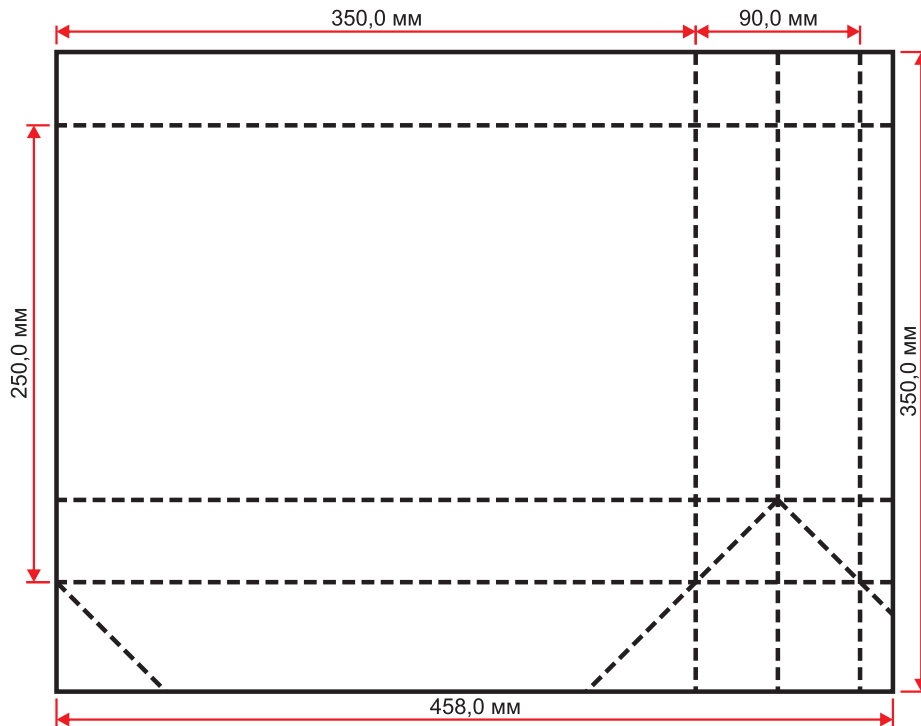

Форма № ЕК1947

ID 11278

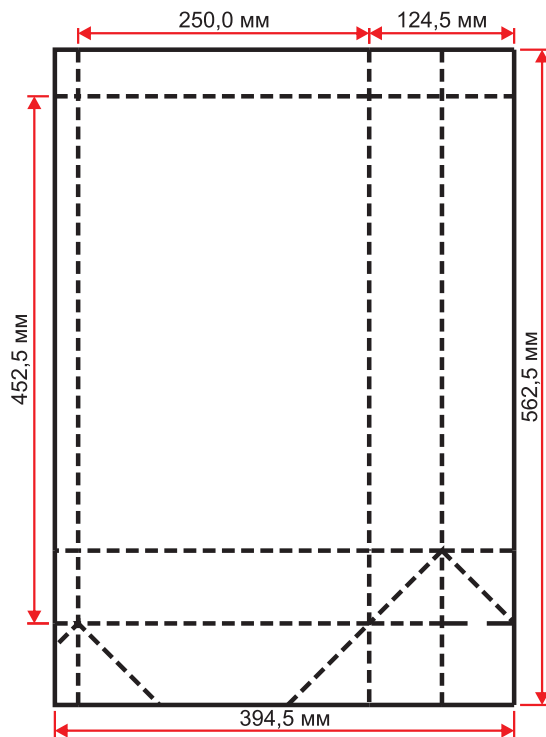

Форма № ЕК1977

ID 11401

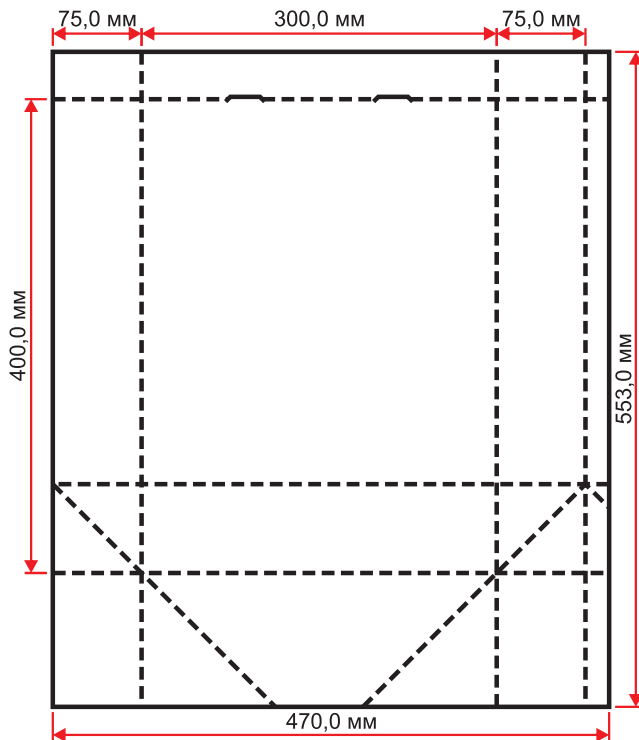

Форма № ЕК1978

ID 11402

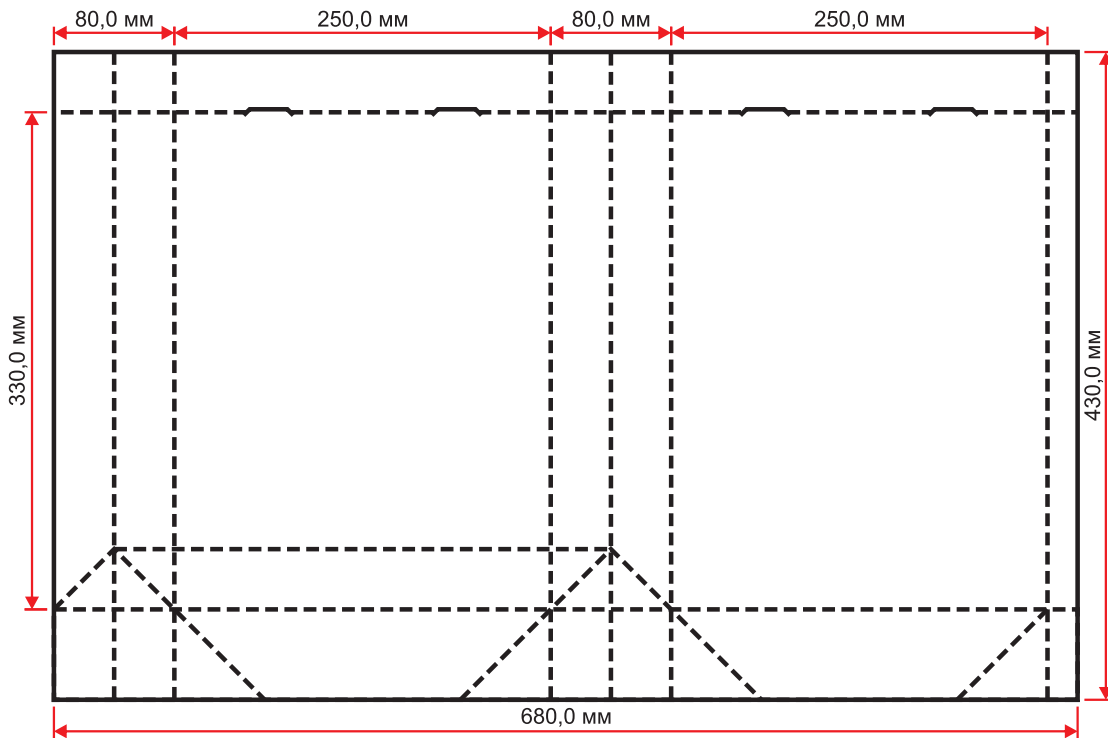

Форма № ЕК2016

ID 11643

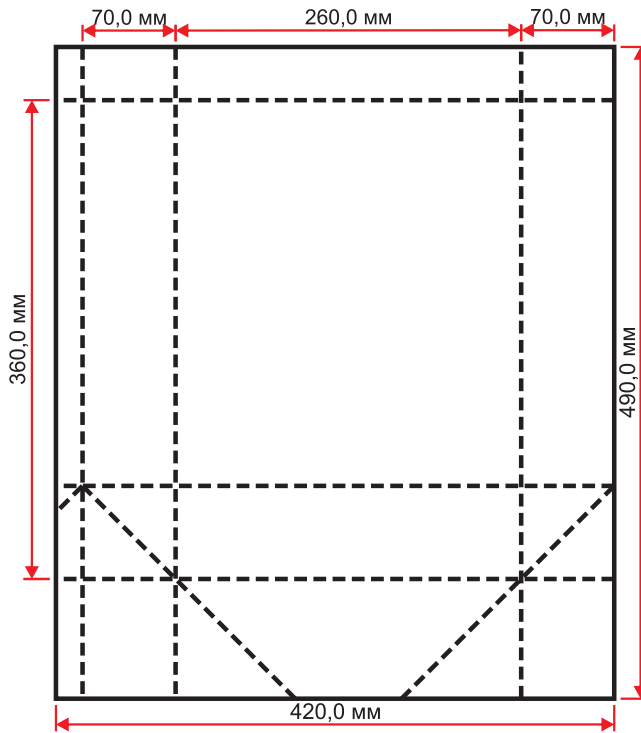

Форма № ЕК2074

ID 11950

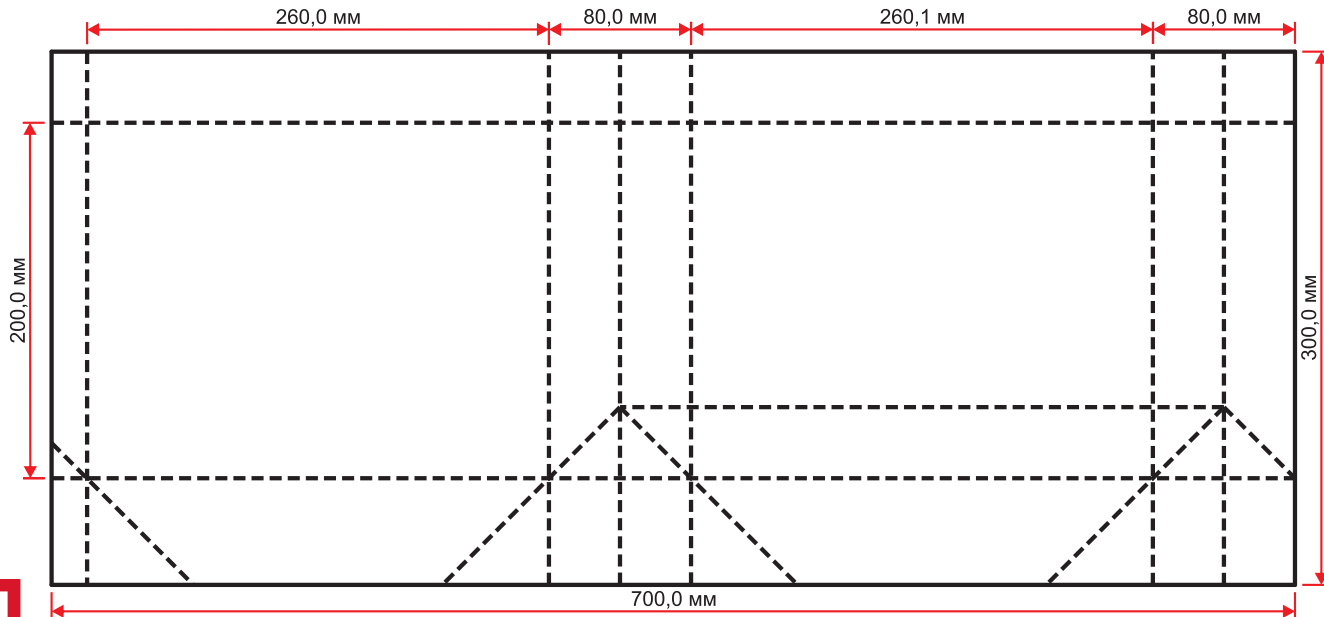



Форма № ЕК2099

ID 12051

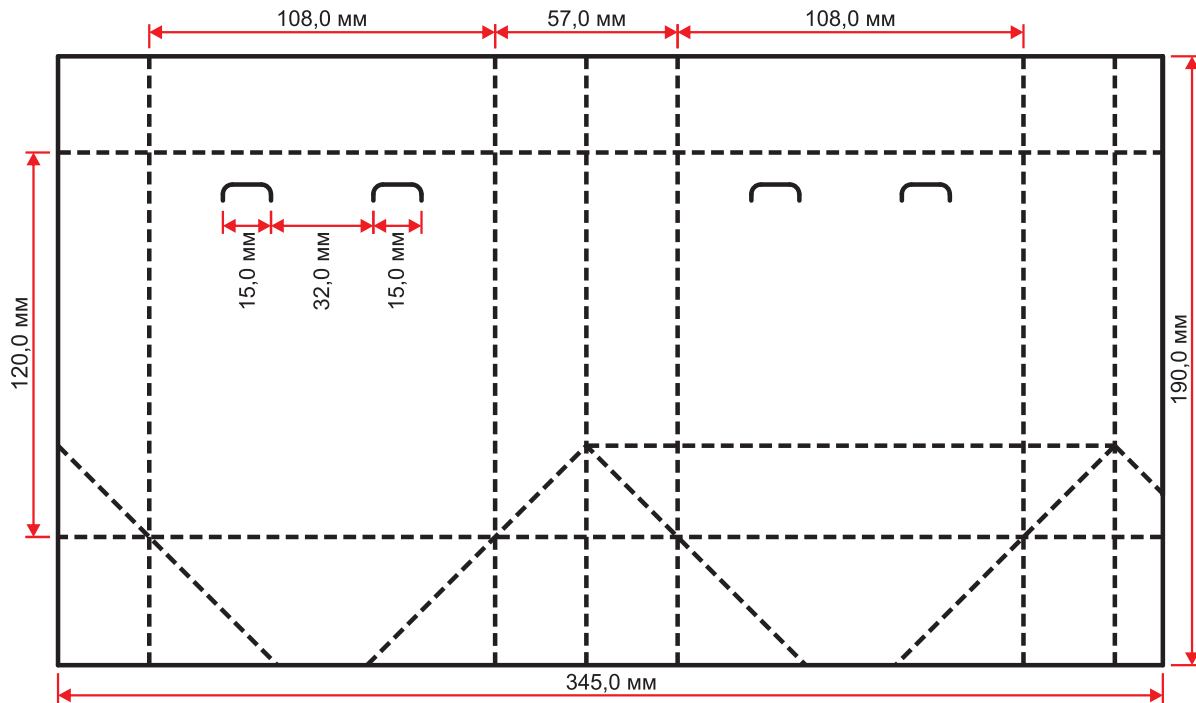

Форма № ЕК2146

ID 12217

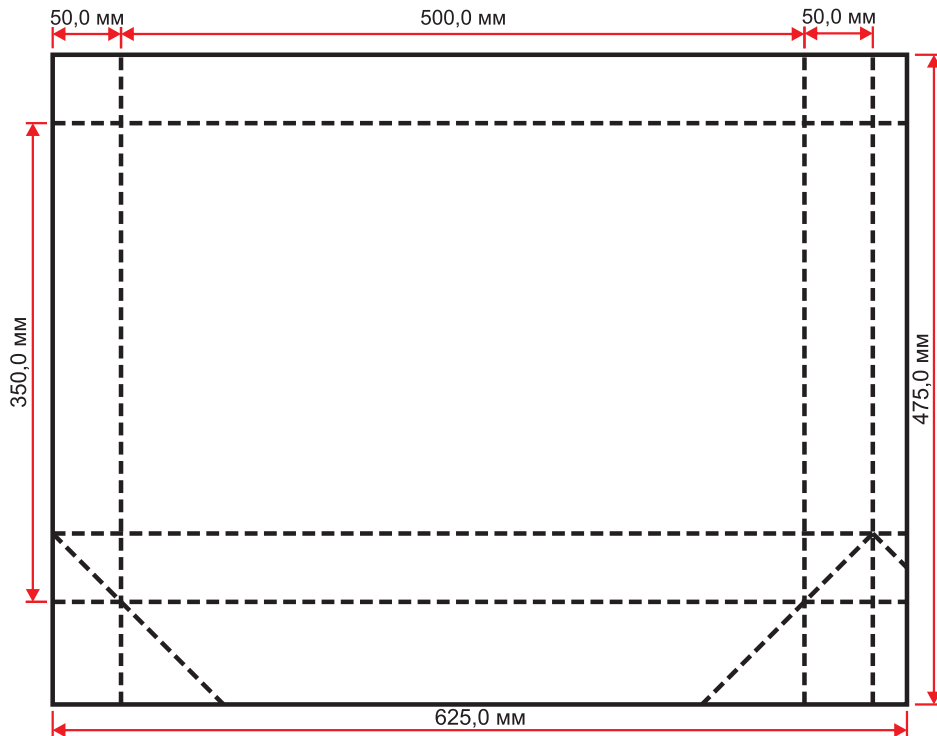

Форма № ЕК2314

ID 13282

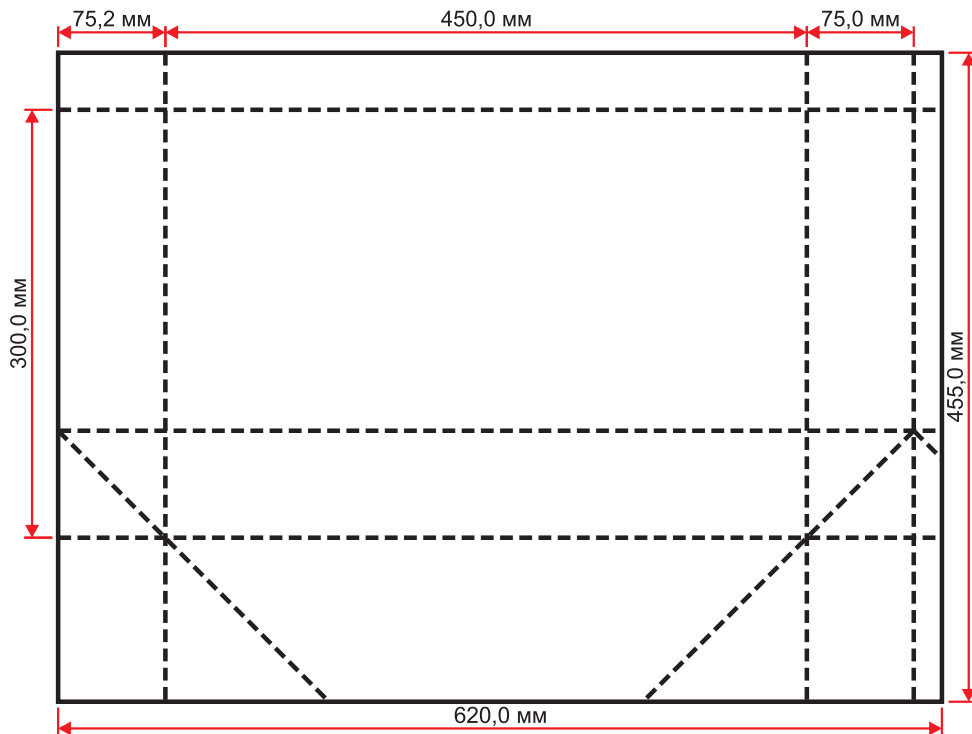

Форма № ЕК2375

ID 13667

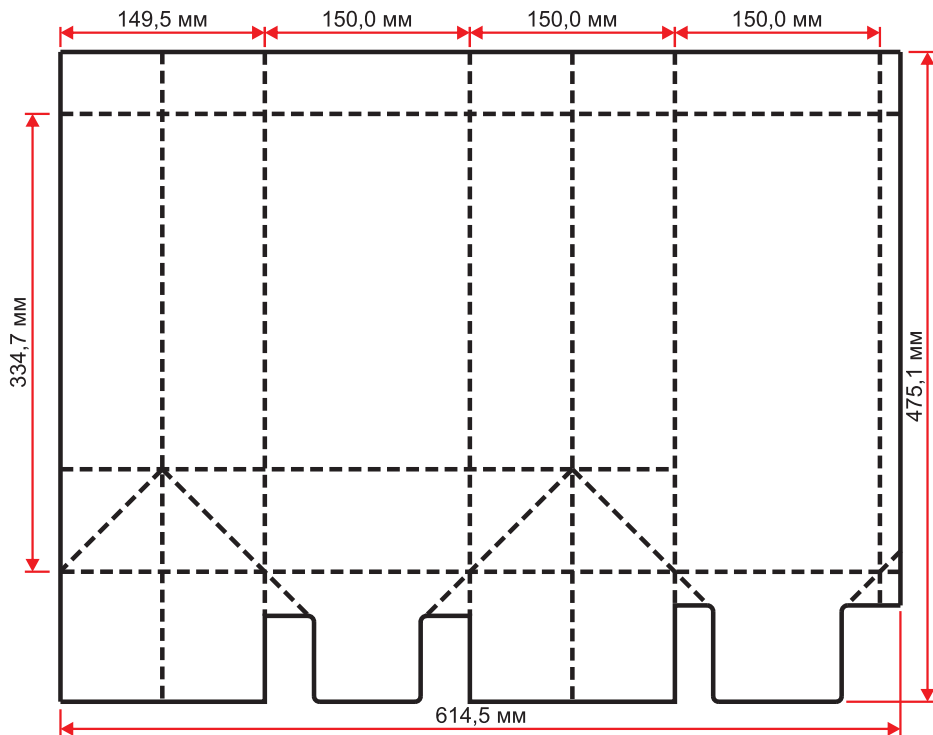

Форма № ЕК2377

ID 13695

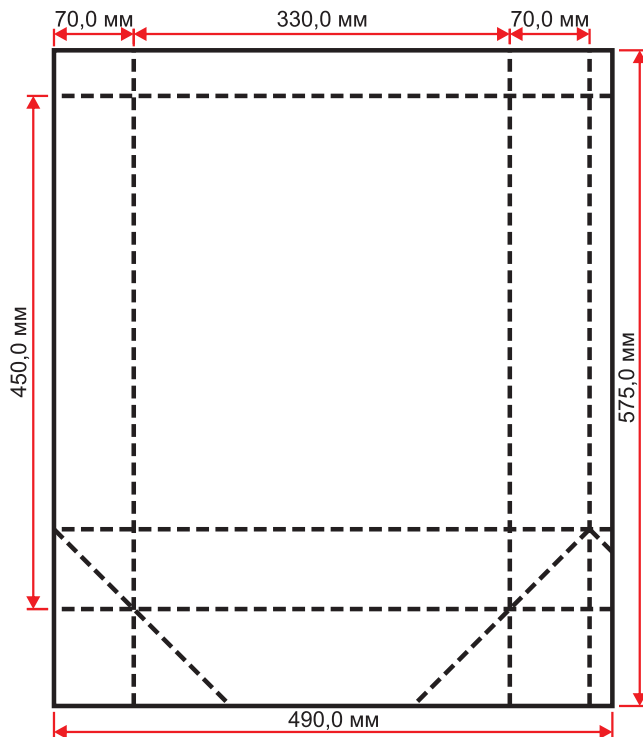

Форма № ЕК2451

ID 14159

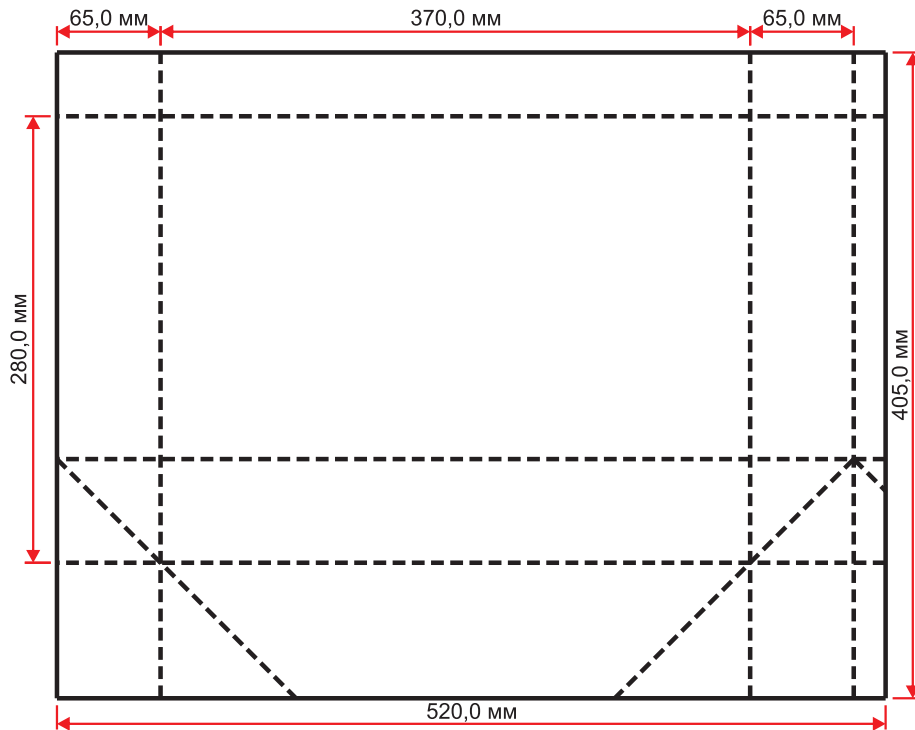

Форма № ЕК2473

ID 14241

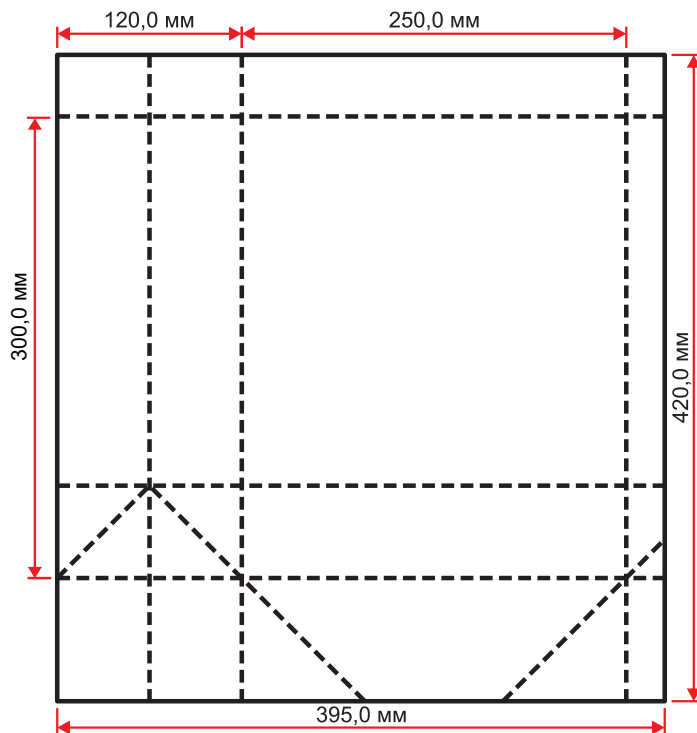

Форма № ЕК2478

ID 14275

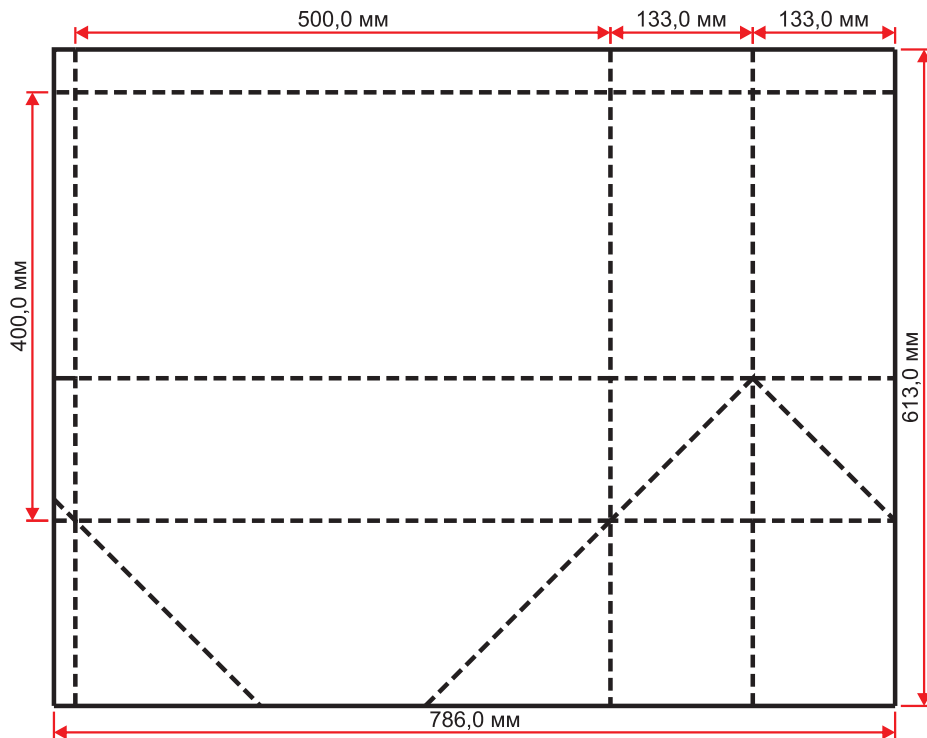



Форма № ЕК2515

ID 14411

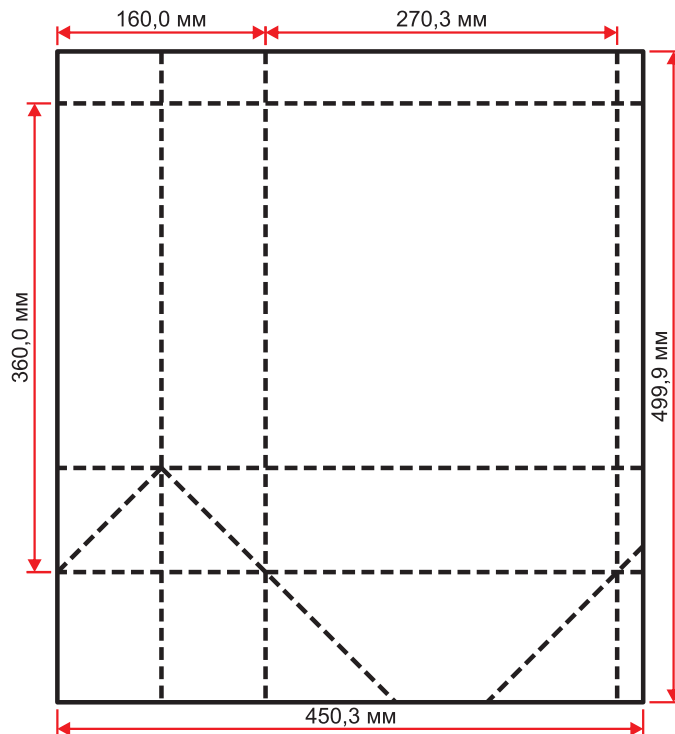

Форма № ЕК2551

ID 14560

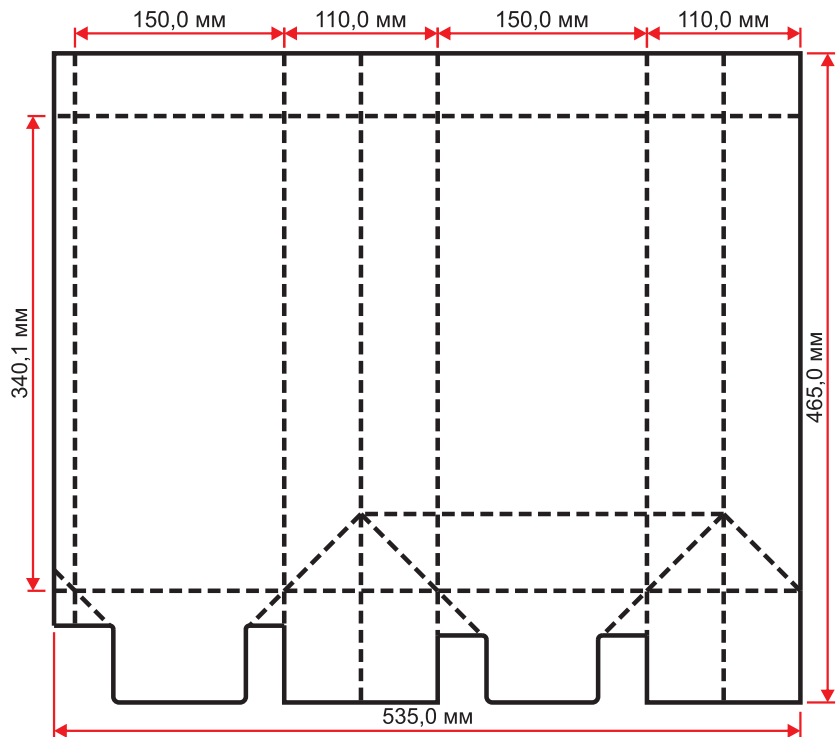

Форма № ЕК2556

ID 14613

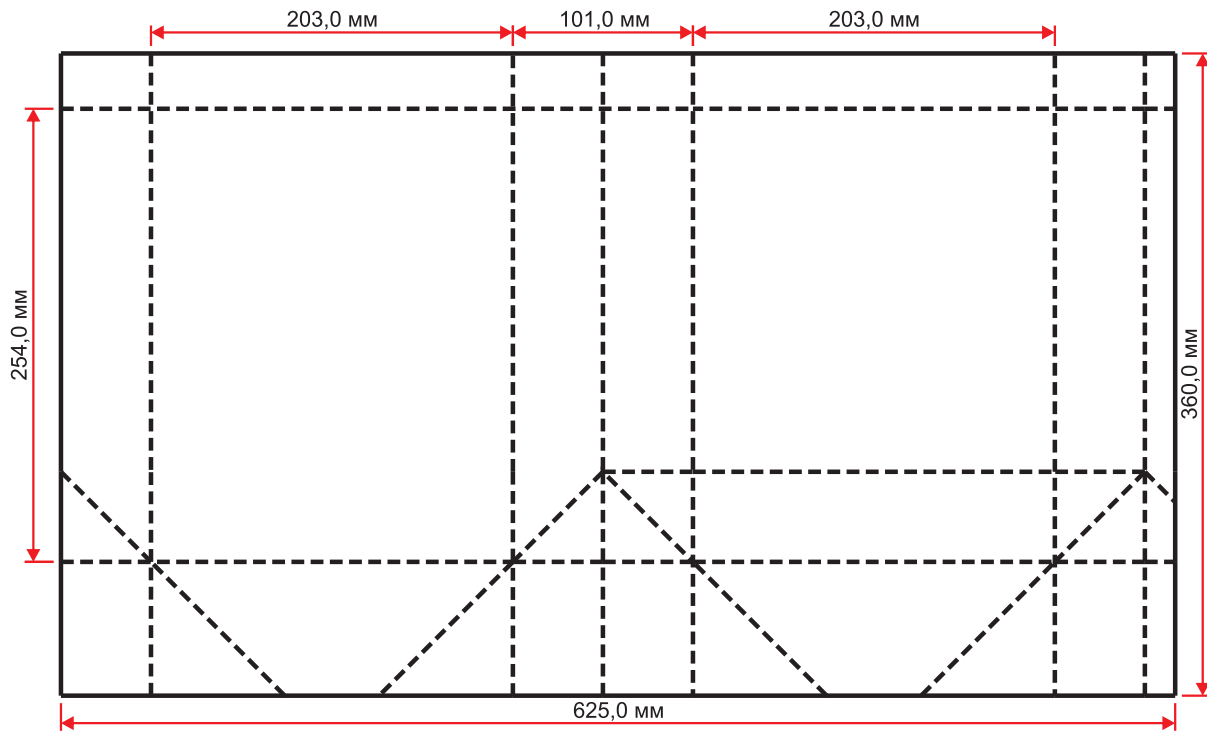

Форма № ЕК2592

ID 14831

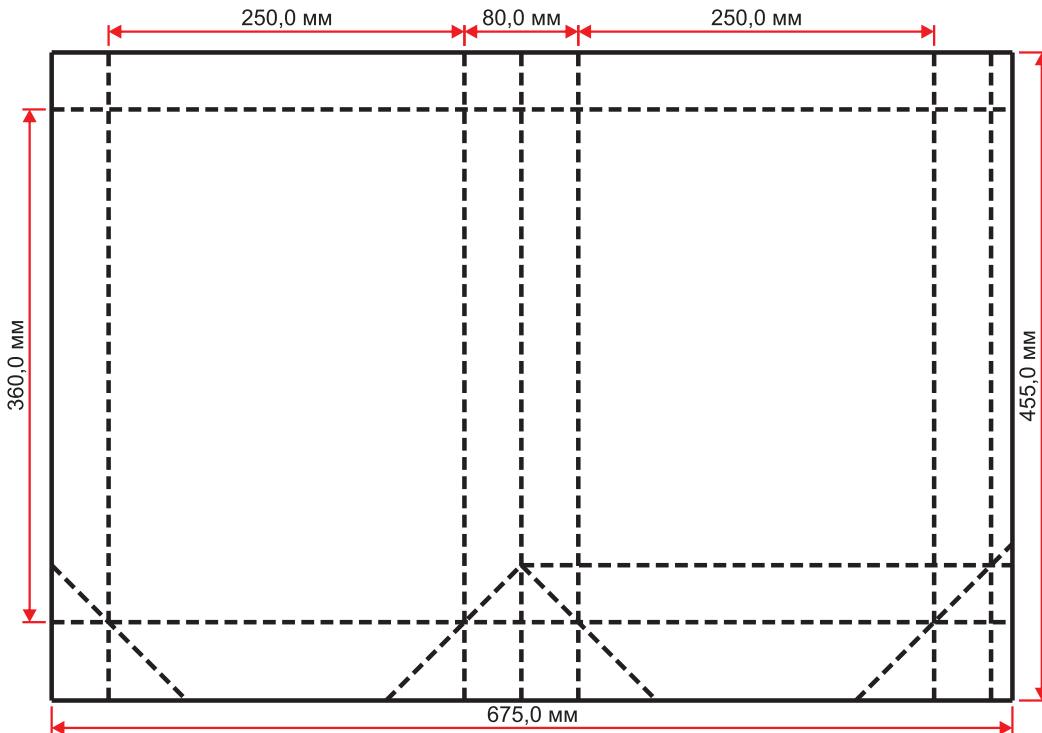

Форма № ЕК2667

ID 15251

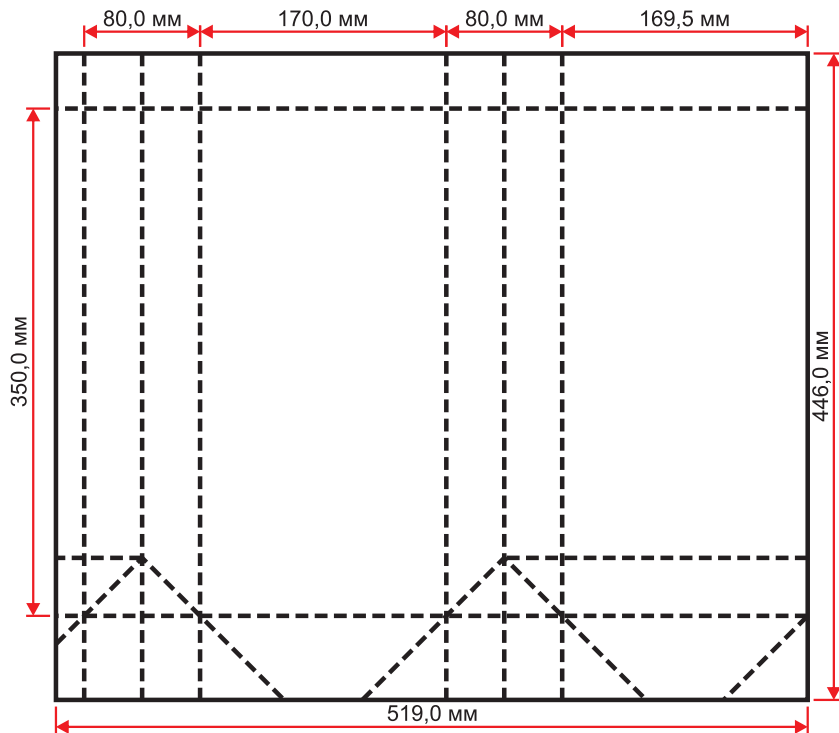

Форма № ЕК2738

ID 15654

